

KINAX WT720
Programmable transmitter
for angular position

Application

The angular position transmitter KINAX WT720 serie is a precision instrument and serves the acquisition of angular position and rotation, processing and the provision of measured values as electric output signals for the downstream device. They convert the angular position of a shaft into a load-independent direct current signal, proportional to the angular position.

The robust design makes the angular position transmitters of the KINAX WT720 series particularly suited to applications in rough environments. As an option is the unit with the adapter flange NLB1019 – an even more robust shaft bearing – available. The products are used in many areas, preferably in power generation, power distribution, energy supply, water, machinery and plant construction, shipping, construction equipment and railway vehicles, materials handling and lifting technology.

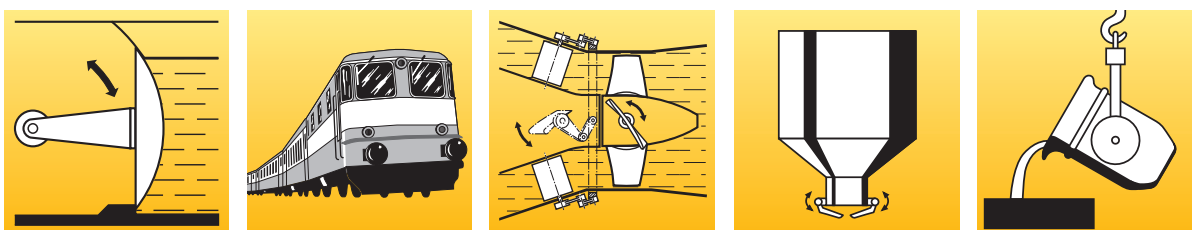

Main features

- Robust transmitter for angular position suitable for field applications
- Highest degree of mechanical and electrical safety
- Proven capacitive scanning system
- No wear, low annual maintenance and mountable anywhere
- Vibration and shock-resistant
- Measuring range, sense of rotation, zero position and linear/V characteristic can be adjusted by a switch and two push-buttons
- Analog output signal 4...20 mA, 2-wire connection
- Zero position and end position are independently adjustable
- Capacitive scanning system provides absolute position immediately after activation

Measuring principle

The capacitive scanning system consists of 2 main parts: the differential screen capacitor and the electronic circuitry. The angular deflection of the device to be measured is transferred to the rotor of the differential screen capacitor with the aid of a mechanical coupling. It is then converted into a change of capacitance proportional to the angle. All changes to the position of the rotor result in a change in the capacitance. This is transformed into a DC current signal proportional to the measured value.

Pin configuration of connector M12 × 1

Pin	WT720
1	+
2	-
3	not connected
4	GND

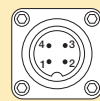

4 poles

Dimensions and mounting KINAX WT720

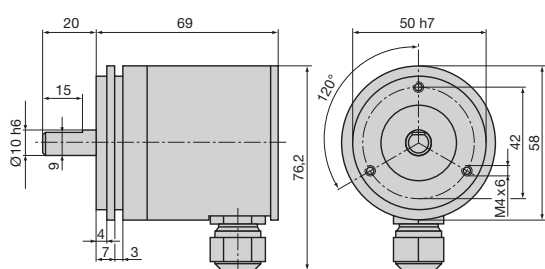

Dimensions KINAX WT720

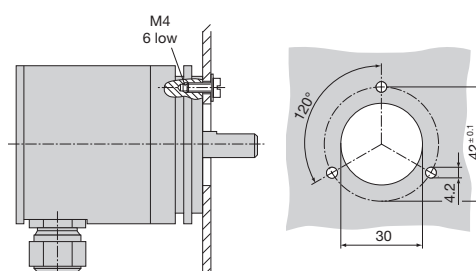

Directly mounting

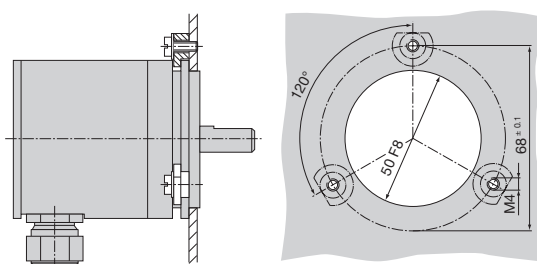
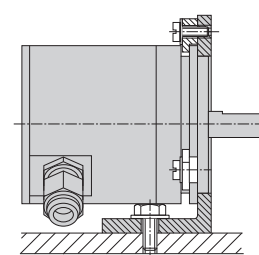

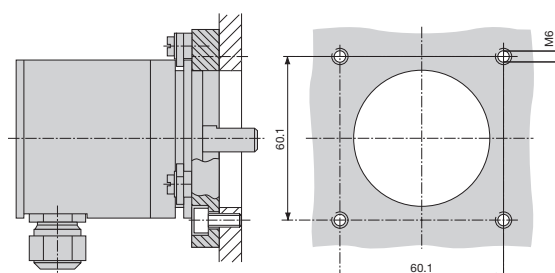

Directly mounting with 3 mounting clamps

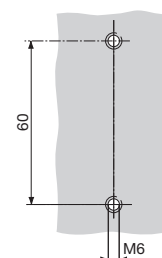

Mounting with mounting plate



Mounting with mounting angle

	KINAX WT720	KINAX WT720 with adapter flange NLB1019
		
General data		
Measured quantity	Angular position	
Measuring principle	Capacitive	
Basic accuracy / error limit	$\leq \pm 0,5 \%$ (reference value 360°)	
Housing protection	IP67 acc. EN 60 529, IP 69k acc. EN 40 050-9	
Housing	Aluminium	
Drive shaft	$\varnothing 10$ mm, rust-proof hardened steel	$\varnothing 19$ mm, rust-proof hardened steel
Electrical connection	Cable gland (metal) or connector (metal, M12 \times 1, 4 poles)	
Weight	Approx. 360 g	Approx. 900 g
Measuring input		
Measuring range	0...360°	
Programmable	By push-buttons and switch: measuring range, zero position, sense of rotation and linear/V characteristic	
Measuring output		
Output signal	4...20 mA, 2-wire connection	
Power supply		
Operation voltage	12...30 V DC	
Environmental conditions and regulations		
Temperature / relative humidity	-20 °C ... +85 °C / $\leq 90\%$ -40 °C ... +85 °C / $\leq 95\%$	
Permissible vibration	≤ 100 m/s ² continuous, ≤ 100 m/s ² / 2h / 10...500 Hz	
Test voltage	All connections against housing: 750 V DC, 1 min.	
Electromagnetic compatibility	The standards EN 61 000-6-4 and EN 61 000-6-2 are observed	

Dimensions and mounting KINAX WT720 with adapter flange NLB1019

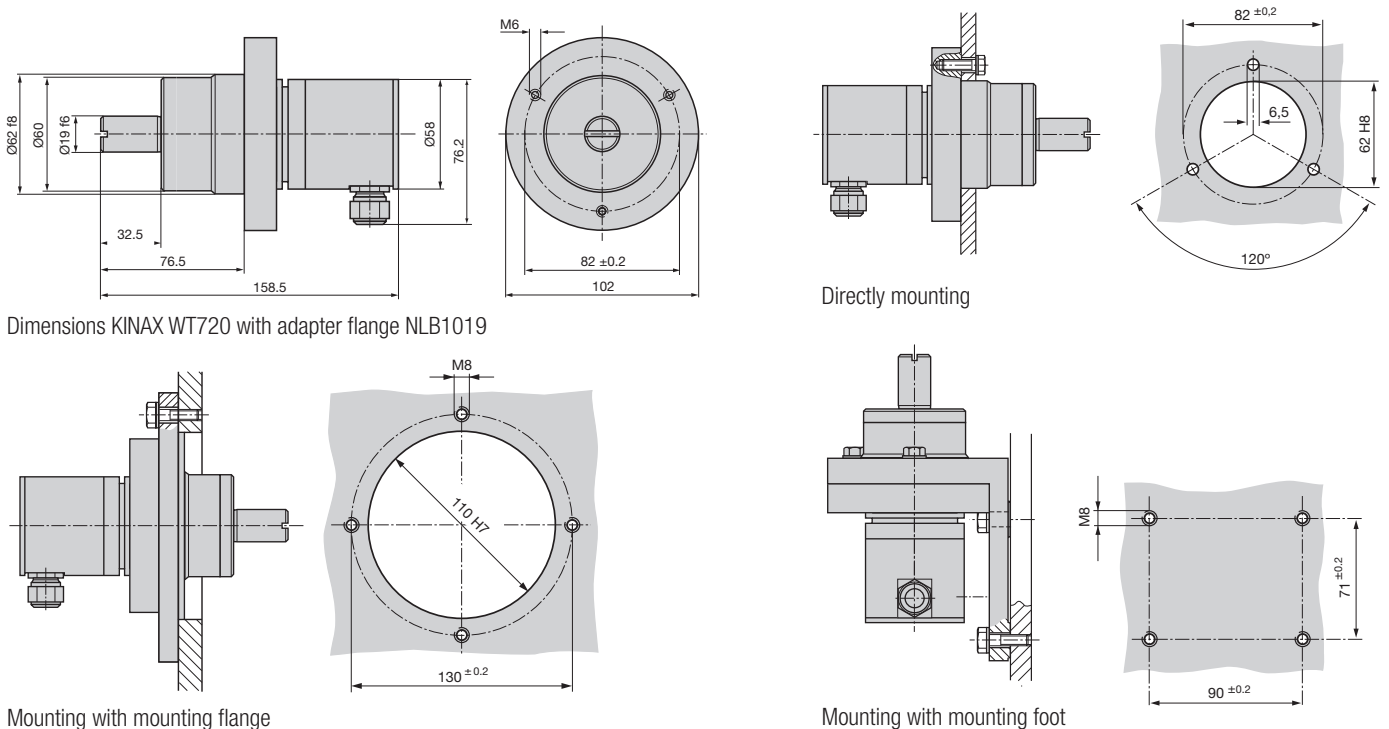

Product ranges of Camille Bauer



Heavy-current: State, Allocation, Quality.



Angular position: Angle, Inclination, Position, Volume.



Process control: Temperature, Signal conversion, Process management.

 **CAMILLE BAUER**

Rely on us.

Camille Bauer AG
Aargauerstrasse 7
CH-5610 Wohlen / Switzerland
Phone: +41 56 618 21 11
Fax: +41 56 618 35 35
info@camillebauer.com
www.camillebauer.com