

Operating Instructions

Universal measuring unit for heavy current variables

SINEAX CAM

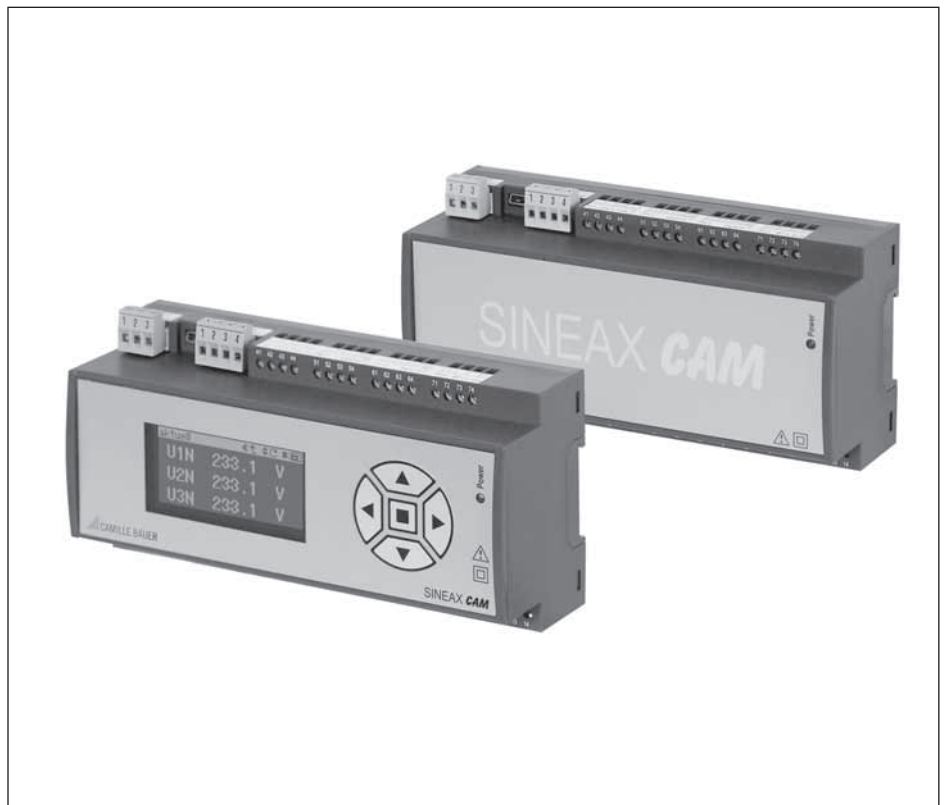

CAM Be

156 481-11

06.10

Camille Bauer Ltd.
Aargauerstrasse 7
CH-5610 Wohlen/Switzerland
Phone +41 56 618 21 11
Fax +41 56 618 35 35
info@camillebauer.com
www.camillebauer.com

 **CAMILLE BAUER**

Operating Instructions

Universal measuring unit for heavy current variables SINEAX CAM

Obligatory safety instructions are marked with the following symbols in these directions:



Device may only be disposed of in a professional manner!

Contents

1. Read first and then.....	3
2. Scope of supply	3
3. Brief description	3
4. Physical installation	3
4.1 Mounting	3
4.2 Releasing.....	4
5. Electrical connections	4
5.1 Inputs and outputs	4
5.2 Interface	6
6. Commissioning.....	7
6.1 Software installation	7
6.2 Parametrization	7
6.3 Simulation / measurement acquisition	8
6.4 Protecting devices.....	8
6.5 MODBUS.....	8
6.6 Graphic display (optional).....	8
6.7 Modbus/TCP	8
6.8 IEC 61850.....	8
7. Technical data	8
7.1 Measurement input	8
7.2 I/O-Interface	10
7.3 Interface	10
7.4 Further information.....	10
7.5 Logger and lists (optional).....	11
8. Maintenance.....	12
9. Dimensional drawings	12
10. Safety notes	12
11. Declaration of conformity	12

1. Read first and then ...



Perfect and safe operation requires that Operating Instructions has been **read** and understood!

This device should only be handled by staff members who are familiar with it and authorised to work on electric facilities.

The device must be closed down if safe operation is not possible any more (e.g. visible damage). All connections are to be switched off. The device must be returned to our plant or to a service centre authorised by us.

An intervention in the device cancels any warranty claim!

2. Scope of supply

- SINEAX CAM (1)
- 1 Safety instructions (2)
- 1 Software and documentation CD (3)
- 1 USB cable (4)

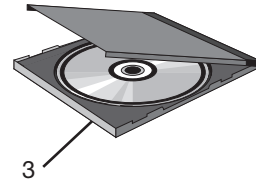
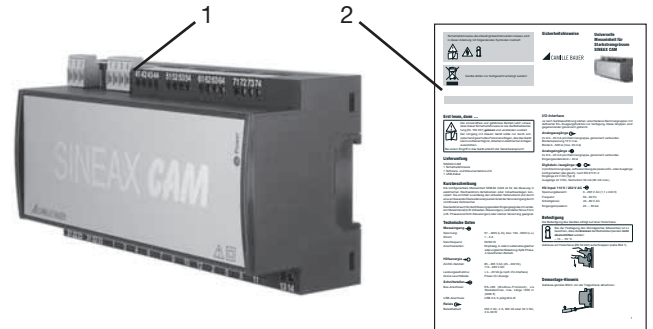

3. Brief description

SINEAX CAM is designed for measurements in electric distribution systems or in industrial facilities. Along with the current system state the pollution due to non-linear loads as well as the overall load of the supply system can be detected. Consistent measurement also guarantees that every network change is reliably acquired and included in measured date. The high-performance measuring system makes the device also suitable for strong distorted systems as well as for zero crossing or phase-angle controls.

The I/O interface may be individually assorted depending on the application. Up to 4 modules with different functionality may be used.

The logger allows long-term recordings of measurement progressions, e.g. to monitor the variable load of transformers, as well as meter readings at definable times. Lists offer the chronological recording of events, alarms or system messages for further analysis of occurrences in the power system.

The graphic display is intended for on-site visualization of measurements, lists and alarms. Via keypad the user can e.g. acknowledge alarms or reset extreme values.

4. Physical installation

4.1 Mounting

The device is mounted on a top-hat rail.



Please ensure that the operating temperature **limits are not exceeded** when determining the place of mounting (place of measurement):

– 10 ... 55 °C

Snap housing on the top-hat rail (EN 50 022) (see Fig. 1).

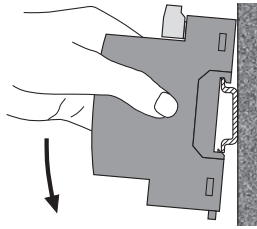

Fig. 1. Mounting on top-hat rail 35 x 15 or 35 x 7.5 mm.

4.2 Releasing

Remove the housing from the mounting rail according to Figure 2.

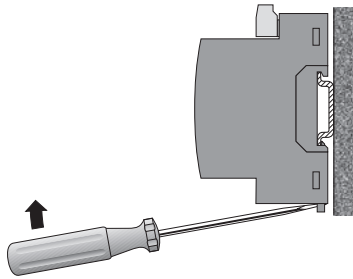

Fig. 2

5. Electrical connections

Screw connections are used. They are designed for cross sections of 4 mm² for single wire leads and 2 x 2.5 mm² for multiwire leads.



Ensure under all circumstances that the leads are free of potential when connecting them!



Please observe, ...
... that the data on the type plate must be adhered to!

A marked and easily accessible switch for turning off the power supply has to be arranged in the vicinity of the device.

In case of a supply of direct current > 125 V DC, an external fuse has to be provided in the power supply circuit.

Otherwise, the national provisions (e.g. in Germany VDE 0100 "Conditions concerning the erection of heavy current facilities with rated voltages below 1000 V") have to be observed in the installation and material selection of electric lines!

5.1 Inputs and outputs

Analog outputs

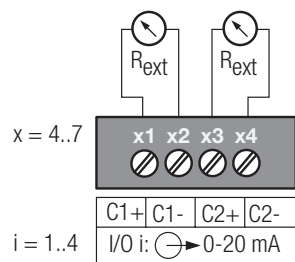

Analog inputs

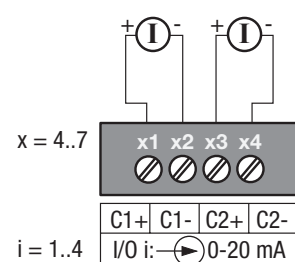

Digital outputs 12/24 V DC

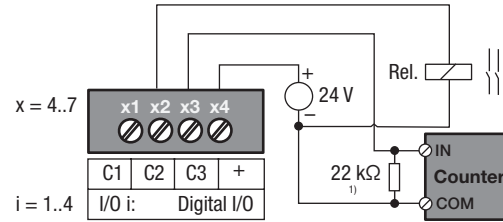

1) Recommended if input resistance > 100 kΩ

Digital inputs 12/24 V DC HV-Input 110/230 VAC

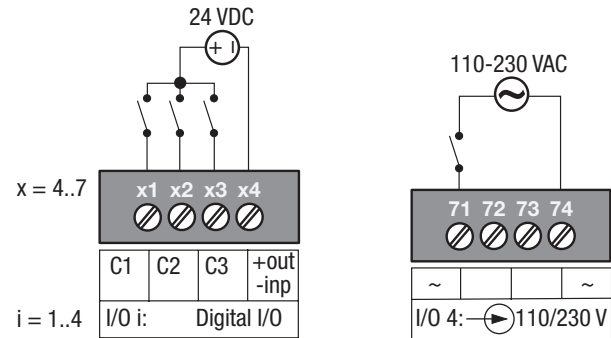

Digital inputs 125 V DC

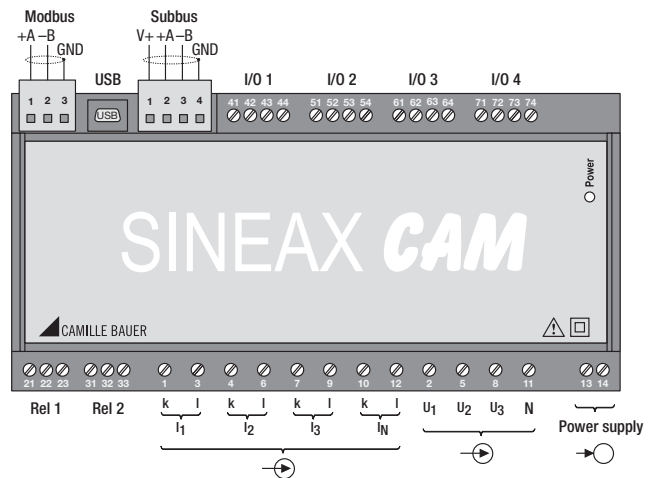
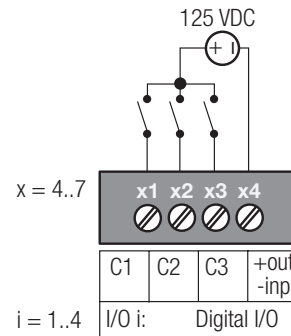

When the device is switched off, the status of the relay contact is not defined. Dangerous voltages may occur.

Connection modes

Network/application	Terminal assignment																	
Single-phase AC mains																		
Three-wire three-phase system balanced load I: L1	<p>Connect voltage according to the following table in case of current measurement via L2 or L3:</p> <table border="1"> <thead> <tr> <th>Current transf.</th> <th>Terminals</th> <th>2</th> <th>5</th> <th>8</th> </tr> </thead> <tbody> <tr> <td>L2</td> <td>1</td> <td>3</td> <td>L2</td> <td>L3</td> <td>L1</td> </tr> <tr> <td>L3</td> <td>1</td> <td>3</td> <td>L3</td> <td>L1</td> <td>L2</td> </tr> </tbody> </table>	Current transf.	Terminals	2	5	8	L2	1	3	L2	L3	L1	L3	1	3	L3	L1	L2
Current transf.	Terminals	2	5	8														
L2	1	3	L2	L3	L1													
L3	1	3	L3	L1	L2													
Four-wire three-phase system balanced load I: L1	<p>Connect voltage according to the following table in case of current measurement via L2 or L3:</p> <table border="1"> <thead> <tr> <th>Current transf.</th> <th>Terminals</th> <th>2</th> <th>11</th> </tr> </thead> <tbody> <tr> <td>L2</td> <td>1</td> <td>3</td> <td>L2</td> <td>N</td> </tr> <tr> <td>L3</td> <td>1</td> <td>3</td> <td>L3</td> <td>N</td> </tr> </tbody> </table>	Current transf.	Terminals	2	11	L2	1	3	L2	N	L3	1	3	L3	N			
Current transf.	Terminals	2	11															
L2	1	3	L2	N														
L3	1	3	L3	N														

Network / application	Terminal arrangement
Three-wire three-phase system asymmetrical load	<p>3 single-pole isolated voltage transformers in the high-voltage system</p>
Three-wire three-phase system asymmetrical load Aron measuring circuit	
Four-wire three-phase system asymmetrical load	<p>3 single-pole isolated voltage transformers in the high-voltage system</p>

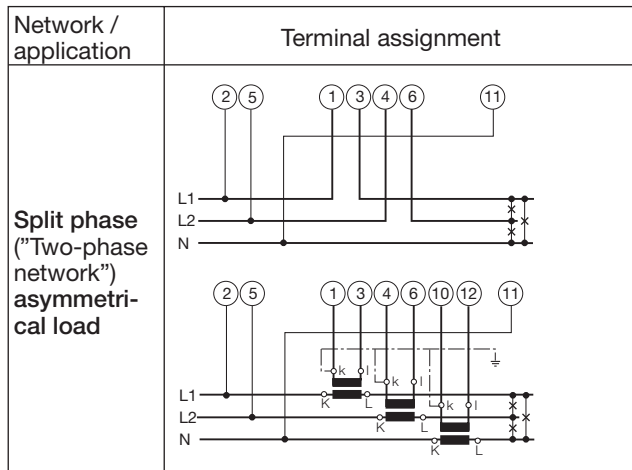
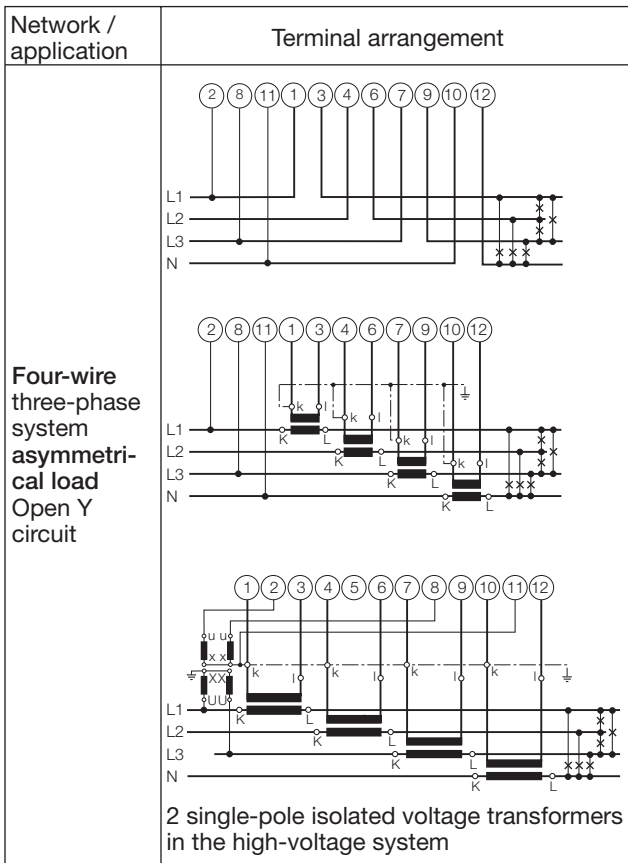

connected with a wire or the cable screen. Screened cables must be used in an environment with interference.

The supply resistors (R_s) must be in the bus master interface. simple RS converters do not have these resistors. Devices that have resistors are e.g. W&T13601 (PC print), and W&T86201 converter from Wiesemann & Theis GmbH).

Avoid drop cables. A straight network is ideal. A maximum of 32 devices can be connected. The bus configuration is made using the CB-Manager software.

5.2 Interface

RS485 bus connection (Modbus)

The terminals (1, 2, 3) are galvanically isolated from the CAM. The signal wires (1, 2) must be twisted. The GND (3) can be

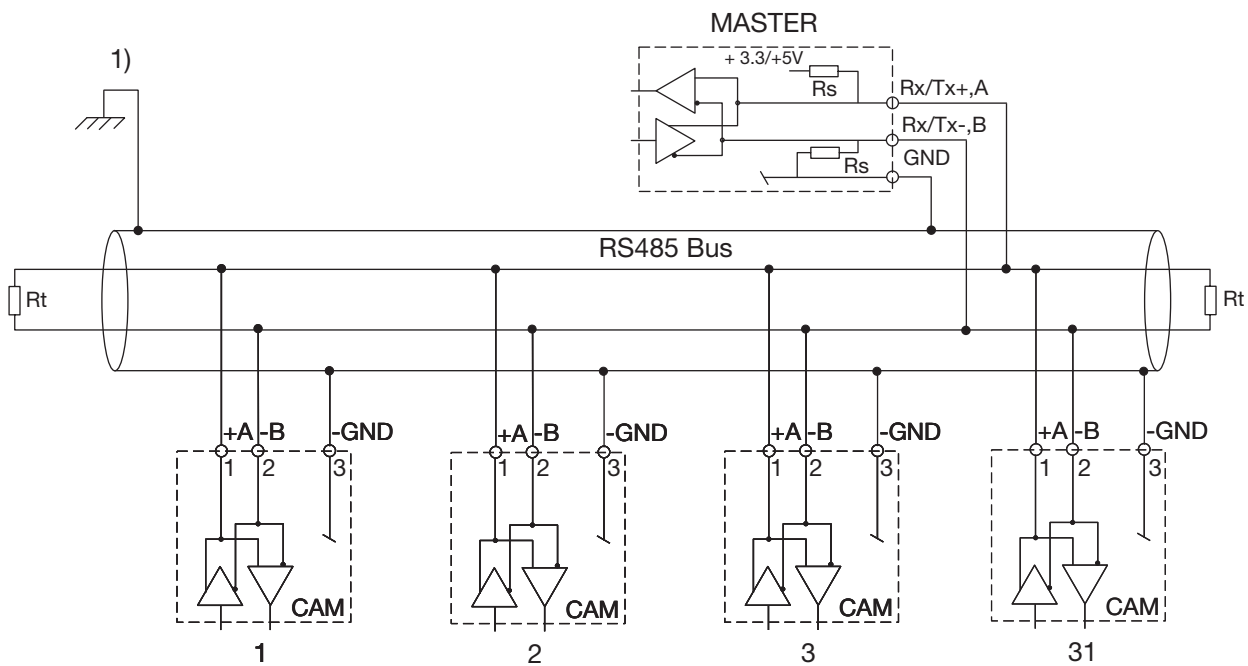

1) One ground connection only. This is possibly already made at the master (PC).

R_t Termination resistors: 120 Ω each for long cables (> approx. 10 m)

R_s Bus supply resistors: 500 ... 1000 Ω each

6. Commissioning



Prior to starting, check that the connection data of the transducer agrees with the system data (see type label).

The power supply to the transducer can then be switched on and the signals applied to the measuring inputs.

- ⊖ Measuring input
 - Input voltage
 - Input current
 - Nominal frequency

- Power supply

- 1 Works No.
- 2 Test and conformity marks
- 3 Terminals current inputs
- 4 Terminals voltage inputs
- 5 Terminals power supply
- 6 Input frequency range

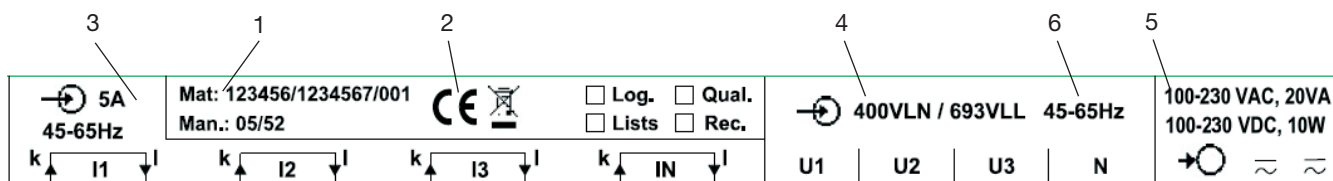

6.1 Software installation

For the parametrization of the device the supplied PC software CB-Manager has to be installed. To do so, execute the file setup.exe in the CB-Manager directory on the CD.



The file "Read Me First.pdf" on the software CD contains all information about the installation of the CB-Manager software as well as assistance for problems concerning USB support.

6.2 Parametrization

The usage of the software is comprehensively described under Help | Contents. There you will find also all detail information, which may also be requested context specific. Hereinafter an overview about existing help topics is shown.

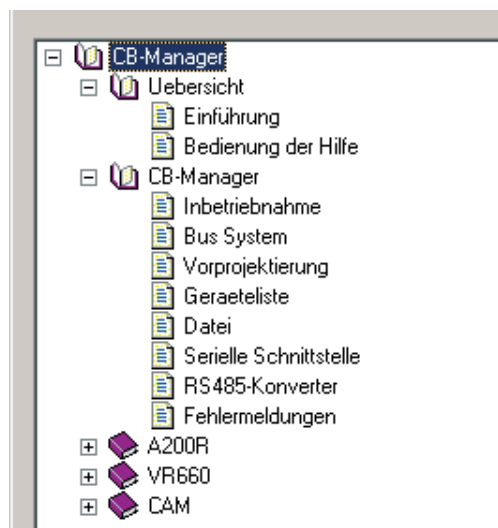

The device configuration may be performed ONLINE (with existing connection to the device) or OFFLINE (without connection to the device). Select Parameter | Edit in the device menu to see an overview of the present settings. You always will be asked if the present parametrization should be read from the device.

The complete configuration of the device is divided in subjects and displayed in a register form. This type of display is well known from the control panel of Windows. In each register you may request context specific help. Therefore this manual will only describe some functions using elements from more than one register.

Sequence

When entering the device configuration you have to consider a useful sequence. After defining the device hardware in the register device you have to enter the input parameters, because all the following inputs will depend on these settings. A help to do this is the function "Next", which navigates you through the registers in a predefined sequence, depending on the selected hardware. This function minimizes possible dependencies.

State signalling to digital or relay outputs

Only via logic module it is possible to output a determined logic state to a digital or relay output. Logic states may be determined from limit value states, states of digital inputs, values received via bus interface or previous calculated logic states. But all these possible logic inputs have to be defined in advance: Limit values in the register limit value and digital inputs in the register I/Ox, which must have the functionality digital input. Further information may be obtained from the help of the logic module.

Meters

Analog or digital inputs may be used to build meters. The definition of the measurands to summarize is done via the I/O registers of the appropriate I/O modules. The register meters will then display all possible meters and provides the possibility to activate the tariff switching to build high and low tariff meters. This meters list does not contain the 12 active and reactive power meters of the standard fitting.

6.3 Simulation / Measurement acquisition

The behaviour of the I/O modules may be simulated during commissioning. By setting states or measurement values it is possible to test if following circuits show the correct behaviour resp. if the SINEAX CAM responds to input devices the right way.

All measurement values may be read via USB or RS485 interface and displayed using the CB-Manager software. Use the device menu "visualisation" and the desired measurement type to go to the appropriate measurement representation and start the acquisition. The data will be displayed and logged. The logged data may be stored on disk for future analysis.

6.4 Protecting devices

For each device user rights can be configured. The right to change configuration data or to set/reset extreme values, meters or slave pointers may be committed this way selectively for up to 3 different users. To perform appropriate functions it is then necessary to enter username and password in advance.

To be able to define user rights the input of an administrator login is required. The factory setting is:

User: **admin**
Password: **admin**

ATTENTION: To reset forgotten passwords it's necessary to send the device back to the factory!

6.5 MODBUS

For customer specific MODBUS solutions the protocol and all necessary information is summarized in the document "SINEAX CAM Modbus interface". This may be found on the CD as well.

6.6 Graphic display (optional)

The parametrization of the graphic display and the assembling of user specific measurement displays is performed using the CB-Manager software. Parameters like contrast or the selection of the display language (English, German, French, Czech, Spanish, Dutch, Italian) can be set also directly using the keypad.

The operation of the graphic display is described in a separate document, which is attached in English and German to all devices equipped with display. The appropriate manuals for all languages may be found on the provided software CD.

6.7 Modbus/TCP

The Ethernet communication by means of the Modbus/TCP protocol is described in the separated document "Modbus/TCP interface SINEAX CAM" (see documentation CD).

6.8 IEC 61850

The IEC 61850 communication is documented separately. See documentation on the CD or on our homepage <http://www.camillebauer.com>

7. Technical data

The complete technical data is given in the data sheet of the device.

7.1 Measurement input (Terminals 1-12)

Frequency range: 45...50/60...65 Hz or
10...50/60...70 Hz or
10...50/60...140 Hz
Measurement TRMS: up to the 63rd harmonic
Measurement category: ≤ 300 V CATIII, ≤ 600 V CATII

Current measurement

Rated current: 1 A (+ 20%), 1 A (+ 100%),
5 A (+ 20%), 5 A (+ 100%)
Overriding max.: 10 A (sinusoidal)
Consumption: ≤ I² x 0.01Ω per phase
Thermal ratings: 12 A continuous
100 A, 10 x 1 s, Interval 100 s

Voltage measurement

Rated voltage: 57.7 ... 400 V_{LN}, 100 ... 693 V_{LL}
Overriding max.: 600 V_{LN}, 1040 V_{LL} (sinusoidal)
Consumption: ≤ U² / 3 MΩ per phase
Input impedance: 3 MΩ per phase
Thermal ratings: 480 V_{LN}, 832 V_{LL} continuous
600 V_{LN}, 1040 V_{LL}, 10 x 10 s,
Interval 10 s
800 V_{LN}, 1386 V_{LL}, 10 x 1 s,
Interval 10 s

System

Single-phase	1L
Split Phase	2L
3-wire system, balanced load	3Lb
3-wire system, unbalanced load	3Lu
3-wire system, unbalanced load (Aron)	3Lu.A
4-wire system, balanced load	4Lb
4-wire system, unbalanced load	4Lu
4-wire system, unbalanced load (Open-Y)	4Lu.O

Basic accuracy under reference conditions

acc. IEC/EN 60 688, sinusoidal 50-60 Hz, 15 to 30 °C

Voltage: ± 0.1% FS ^{a)}
Current: ± 0.1% FS ^{a)}
Power: ± 0.2% FS ^{b)}
Power factor: ± 0.1°
Frequency: ± 0.01 Hz
Voltage unbalance: ± 0.2%
Harmonics: ± 0.5%
THD Voltage: ± 0.5%
TDD Current: ± 0.5%
Energy: ± 0.2% FS ^{b)}
Active energy
direct connection: Kl. 1 / EN 62 053-21
Active energy
transformer connection: Kl. 2 / EN 62 053-21
Reactive energy: Kl. 2 / EN 62 053-23

Influence quantities and permissible variations

According to IEC / EN 60 688

a): FS: Maximum value of the input configuration
(Full Scale)

b): FS: FS-Voltage x FS-Current

System analysis quantities

Measured quantity		present	max	1L	2L	3Lb	3Lu	3Lu.A	4Lb	4Lu	4Lu.0
Voltage unbalance	unb. U	●	●								
THD Voltage	THD.U1N	●	●	✓	✓				✓	✓	✓
THD Voltage	THD.U2N	●	●		✓				✓	✓	✓
THD Voltage	THD.U3N	●	●						✓	✓	✓
THD Voltage	THD.U12	●	●			✓	✓	✓			
THD Voltage	THD.U23	●	●			✓	✓	✓			
THD Voltage	THD.U31	●	●			✓	✓	✓			
TDD Current	TDD.I1	●	●	✓	✓	✓	✓	✓	✓	✓	✓
TDD Current	TDD.I2	●	●		✓		✓	✓		✓	✓
TDD Current	TDD.I3	●	●				✓	✓		✓	✓
Harmonics	H2-50.U1	●	●	✓	✓				✓	✓	✓
Harmonics	H2-50.U2	●	●		✓					✓	✓
Harmonics	H2-50.U3	●	●							✓	✓
Harmonics	H2-50.U12	●	●			✓	✓	✓			
Harmonics	H2-50.U23	●	●			✓	✓	✓			
Harmonics	H2-50.U31	●	●			✓	✓	✓			
Harmonics	H2-50.I1	●	●	✓	✓	✓	✓	✓	✓	✓	✓
Harmonics	H2-50.I2	●	●		✓		✓	✓		✓	✓
Harmonics	H2-50.I3	●	●				✓	✓		✓	✓

THD U (Total Harmonic Distortion): Harmonic content related to the fundamental of the RMS value of voltage.

TDD I (Total Demand Distortion): Harmonic content related to the fundamental of the RMS value of the rated current.

Basic measurement quantities

Measured quantity		present	max	min	1L	2L	3Lb	3Lu	3Lu.A	4Lb	4Lu	4Lu.0
Voltage	U	●	●	●	✓	✓				✓	✓	✓
Voltage	U1N	●	●	●	✓	✓				✓	✓	✓
Voltage	U2N	●	●	●		✓				✓	✓	✓
Voltage	U3N	●	●	●						✓	✓	✓
Voltage	U12	●	●	●			✓	✓	✓	✓	✓	✓
Voltage	U23	●	●	●			✓	✓	✓	✓	✓	✓
Voltage	U31	●	●	●			✓	✓	✓	✓	✓	✓
Voltage	UNE	●	●	●						✓	✓	✓
Current	I	●	●		✓		✓			✓	✓	✓
Current	I1	●	●			✓		✓	✓	✓	✓	✓
Current	I2	●	●				✓	✓	✓	✓	✓	✓
Current	I3	●	●					✓	✓	✓	✓	✓
I-Bimetal 1-60 min	IB	●	●		✓		✓			✓	✓	✓
I1-Bimetal 1-60 min	IB1	●	●			✓		✓	✓	✓	✓	✓
I2-Bimetal 1-60 min	IB2	●	●				✓	✓	✓	✓	✓	✓
I3-Bimetal 1-60 min	IB3	●	●					✓	✓	✓	✓	✓
Neutral current	IN	●	●			✓				✓	✓	✓
Active power Σ	P	●	●		✓	✓	✓	✓	✓	✓	✓	✓
Active power	P1	●	●			✓				✓	✓	✓
Active power	P2	●	●				✓			✓	✓	✓
Active power	P3	●	●					✓		✓	✓	✓
Reactive power Σ	Q	●	●		✓	✓	✓	✓	✓	✓	✓	✓
Reactive power	Q1	●	●			✓				✓	✓	✓
Reactive power	Q2	●	●				✓			✓	✓	✓
Reactive power	Q3	●	●					✓		✓	✓	✓

Measured quantity		present	max	min	1L	2L	3Lb	3Lu	3Lu.A	4Lb	4Lu	4Lu.0
Apparent power Σ	S	●	●		✓	✓	✓	✓	✓	✓	✓	✓
Apparent power	S1	●	●			✓					✓	✓
Apparent power	S2	●	●			✓					✓	✓
Apparent power	S3	●	●								✓	✓
Frequency	F	●	●	●	✓	✓	✓	✓	✓	✓	✓	✓
Active power factor Σ	PF	●			✓	✓	✓	✓	✓	✓	✓	✓
Active power factor	PF1	●				✓					✓	✓
Active power factor	PF2	●				✓					✓	✓
Active power factor	PF3	●									✓	✓
PF Σ Incoming ind.				●	✓	✓	✓	✓	✓	✓	✓	✓
PF Σ Incoming cap.				●	✓	✓	✓	✓	✓	✓	✓	✓
PF Σ Outgoing ind.				●	✓	✓	✓	✓	✓	✓	✓	✓
PF Σ Outgoing cap.				●	✓	✓	✓	✓	✓	✓	✓	✓
React. power factor Σ	QF	●			✓	✓	✓	✓	✓	✓	✓	✓
React. power factor	QF1	●				✓					✓	✓
React. power factor	QF2	●				✓					✓	✓
React. power factor	QF3	●									✓	✓
LF power factor Σ	LF	●			✓	✓	✓	✓	✓	✓	✓	✓
LF power factor	LF1	●				✓					✓	✓
LF power factor	LF2	●				✓					✓	✓
LF power factor	LF3	●									✓	✓
(U1N+U2N) / 2	Um	●				✓						
(U1N+U2N+U3N) / 3	Um	●									✓	✓
(U12+U23+U31) / 3	Um	●						✓	✓			
(I1+I2) / 2	Im	●				✓						
(I1+I2+I3) / 3	Im	●						✓	✓		✓	✓

Measurement calculation acc. DIN 40 110 incl. 4-quadrant measurement.

Energy meters (High and low tariff)

Active energy: Incoming
 Active energy: Outgoing
 Reactive energy: Incoming
 Reactive energy: Outgoing
 Reactive energy: inductive
 Reactive energy: capacitive

Relationship between PF, QF and LF

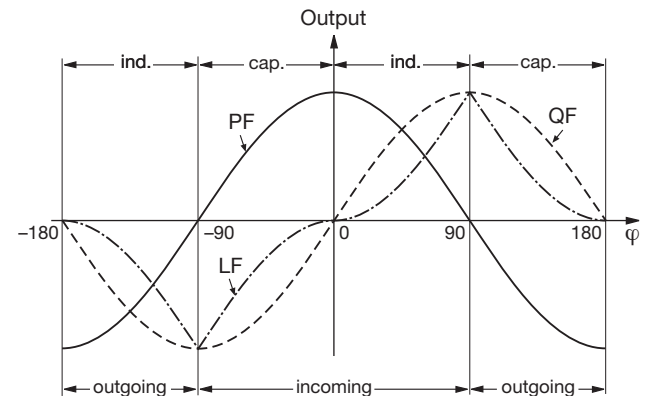

Fig. 3. Active power factor PF —, reactive power factor QF -----, power factor LF -.-.-.-.

7.2 I/O-Interface

Relay (Terminals 21-23, 31-33)

Number:	2
Contacts:	Changeover contact
Load capacity:	250 V AC, 2 A, 500 VA 30 V DC, 2 A, 60 W

I/O-Module (optional, Terminals 41-74)

Up to 4 different groups of terminals (41-44, 51-54, 61-64, 71-74) with defined input/output functions are available depending on the selected options. These groups are galvanically isolated from each other and from the rest of the device.

The following modules are available:

Analog outputs

2 active current outputs per group of terminals

Linearization:	linear, quadratic, kinked
Range:	0/4-20 mA (24 mA max.), unipolar or ± 20 mA (24 mA max.), bipolar
Accuracy:	± 0.1% of 20 mA
Burden:	≤ 500 Ω (max. 10 V / 20 mA)
Galvanical isolation:	From all other connections (connected within group of terminals)

Analog inputs

2 current inputs per group of terminals

Range:	0/4-20 mA (24 mA max.), unipolar
Accuracy:	± 0.1% of 20 mA
Galvanical isolation:	From all other connections (connected within group of terminals)

Digital inputs/outputs

3 per group of terminals, in relation to software configurable as passive inputs or outputs (all the same), acc. EN 61 131-2

Inputs (acc. EN 61 131-2 DC 24 V Type 3):

Function:	State input, pulse counter
Rated voltage:	12/24 V DC (30 V max.)
Input current:	< 7.0 mA
Counting frequency (S0):	≤ 50 Hz
Logical ZERO:	- 3 till + 5 V
Logical ONE:	8 till 30 V
Switching limit:	approx. 6.5 V / 2.6 mA

Outputs (partly acc. EN 61 131-2):

Function:	State output, pulse output, self-monitoring
Rated voltage:	12/24 V DC (30 V max.)
Rated current:	50 mA (60 mA max.)
Switching frequency (S0):	≤ 20 Hz
Load capacity:	400 Ω ... 1 MΩ

Digital inputs 125 V DC

3 per group of terminals

Function	State input
Rated voltage	48 / 125 V DC (157 V max.)

Input current	< 2.5 mA
Counting frequency (S0)	≤ 50 Hz
Logical ZERO	- 6 till + 20 V
Logical ONE	30 till 157 V
Switching limit	Approx. 25 V / 0.8 mA

HV-Input 110/230 V AC (for terminals 71, 74 only)

1 input for RTC synchronization or state recognition

Function:	Synchronization RTC, Logic
Rated voltage:	110 till 230 V AC (≥ 100 V AC, ≤ 264 V AC)
Frequency range:	45 till 65 Hz
Logical ZERO:	0 till 40 V AC
Logical ONE:	80 till 264 V AC
Switching limit:	Approx. 60 V AC / 1.9 mA ± 20%

7.3 Interface

Modbus connection (plug-in screw terminals 1, 2, 3)

Function:	Configuration, Measurement acquisition
Protocol:	Modbus RTU
Physics:	RS-485, max. distance 1200 m (4000 ft)
Baudrate:	Configurable (1.2 till 115.2 kBaud)
Number of bus stations:	≤ 32

USB connection (USB Mini-B, 5 contacts)

Function:	Configuration, Measurement acquisition
Protocol:	USB 2.0

Subbus connection (plug-in screw terminals 1, 2, 3, 4)

Function:	reserved for future device options
-----------	------------------------------------

Ethernet (RJ-45), optional

Function:	Configuration, measurement acquisition
Protocol:	Modbus/TCP or IEC 61850 (depending on the version ordered)

7.4 Further information

Power supply (Terminals 13, 14)

Option 1:

AC, 50 - 400 Hz:	100 ... 230 V ± 15%
DC:	100 ... 230 V ± 15%
Consumption:	≤ 10 W resp. ≤ 20 VA
Inrush current:	< 25 A / 0.3 ms

Option 2:

DC:	24 ... 60 V ± 15%
Consumption:	≤ 10 W

Limit module (Software function GW1 till 64)

64 Limit values for monitoring measurement limits

Limit for ON state:	programmable
Limit for OFF state:	programmable

Logic module (Software function LS1 till 32)

32 Logic functions to combine logical states: Limit values, digital inputs, LS-states and default values. Output to digital outputs, relays or other LS functions possible.

Internal clock (RTC)

Function:	Time reference, Counter for operating hours
Accuracy:	± 2 Minutes/Month (15 till 30°C) trimmable via PC-Software
Synchronization via:	Measurement input, HV-Input 110/230 V AC, Synchronization pulse (digital input)
Running reserve:	> 10 years

Response time

The total response time is the addition of the measurement time t_1 of the input quantities and the processing time t_2 for the respective output (analog output, bus, digital output, relay).

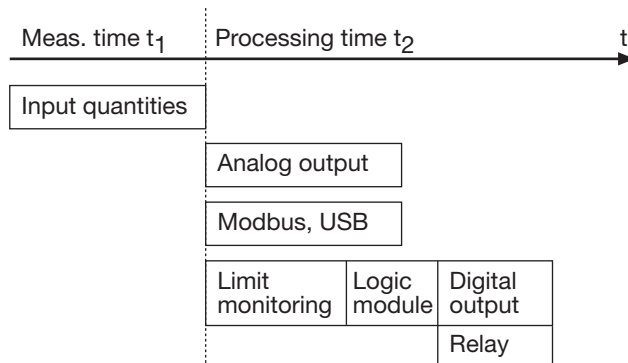

Measurement time t_1

Basic measurement quantities

Measurement interval:	programmable, 1 .. 999 periods (Averaging time RMS value)
Measurement time t_1 :	2 x measurement interval + 17ms

System analysis quantities

Measurement interval:	18 periods
Measurement time t_1 :	2 x measurement interval

Analog input

Measurement time t_1 :	25 ms .. 30 s (programmable)
--------------------------	------------------------------

Digital input

Measurement time t_1 :	< 25 ms
--------------------------	---------

HV-Input 110/230 V AC

Measurement time t_1	2 till 255 periods (programmable)
------------------------	-----------------------------------

Total response time $t_1 + t_2$

Analog output:	$t_1 + 10$ ms .. 60 s, programmable
Modbus / USB:	t_1
Digital output:	$t_1 + 8$ ms + Logic module
Relay:	$t_1 + 30$ ms + Logic module

(Logic module: Switch-in/dropout delay 0...65 s, programmable)

Example: Relay has to toggle if $P > P_{\text{limit}}$, rated frequency is 50 Hz, Averaging time is 1 period, switch-in delay logic set to 0 s

Response time 40ms + 17ms + 0ms + 30ms = 87ms

Ambient conditions, general information

Operating temperature:	- 10 till 15 till 30 till 55 °C
Storage temperature:	- 25 till + 70 °C
Relative humidity:	< 95% no condensation
Variations due to ambient temperature:	0.5x Basic accuracy per 10 K
Long term drift:	0.2x Basic accuracy per year
Altitude:	≤ 2000 m max.
Others:	Usage group II acc. IEC / EN 60 688

Mechanical attributes

Dimensions:	186 x 90 x 62 mm
Mounting:	On top-hat rail acc. DIN EN 50 022 (35 x 15 mm and 35 x 7.5 mm)
Orientation:	Any
Housing material:	Polycarbonat (Makrolon)
Flammability class:	V-0 acc. UL 94, self-extinguishing, non-dripping, free of halogen
Weight:	500 g

Security

The current inputs are galvanically isolated from each other.

Protection class:	II (protective insulation, voltage inputs via protective impedance)
Pollution degree:	2
Enclosure protection:	IP 40, housing (test wire, IEC/EN 60 529) IP 20, terminals (test finger, IEC/EN 60 529)
Measurement category:	CAT III (at ≤ 300 V versus earth) CAT II (at > 300 V versus earth)
Rated voltage (versus earth):	Power supply: 265 V AC Relay: 250 V AC I/O's: 30 V DC 264 V AC(HV-Input)

7.5 Logger and lists (optional)

By means of these options measurements and events may be long-term recorded. Depending on the application 7 different kinds of data may be acquired:

- Progression of mean-values with interval time t_1 (1s...60min)
- Progression of mean-values with interval time t_2 (1s ... 60min)
- Min/Max values during interval t_3 (1s ... 3h)
- Meter readings
- List entries of alarms
- List entries of events
- List entries of system messages

They share the available storage space of 64Mb size. The memory allocation may be performed using the CB-Manager

software. Due to the high degree of freedom for the configuration of logger and lists no general information about the maximal storage duration can be given. But these can be seen in the software when selecting the memory allocation, the measurands to store and the number of list entries.

The reading and analyzing of logger and list data can be done using the **CB-Analyzer** software.

8. Maintenance

Before delivery the device is checked to assure your personal safety. Unauthorized opening of the device invalidates the warranty and the unit must be sent back to the factory for repeating all necessary checks.

The calibration of the device and the alteration of the I/O module disposition can be performed in our factory only. We recommend a yearly recalibration of the device to ensure the long-term accuracy.

9. Dimensional drawings

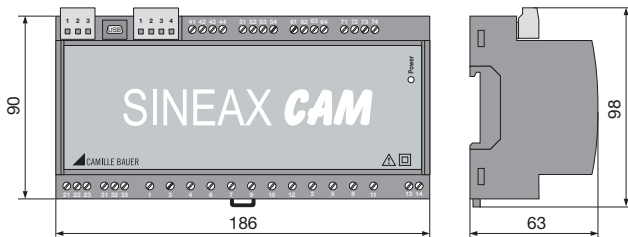

10. Safety notes

- Before you start the device check for which power supply it is built.
- Verify that the connection leads are in good condition and that they are electrically dead while wiring the device.
- When it must be assumed that safe operation is no longer possible, take the device out of service (eventually disconnect the power supply and the input voltage!).

This can be assumed on principle when the device shows obvious signs of damage.

The device must only be used again after troubleshooting, repair and a final test of calibration and dielectric strength in our factory or by one of our service facilities.

- **When opening the cover, live parts may be exposed.**

Calibration, maintenance or repair with the device open and live must only be performed by a qualified person who understands the danger involved. Capacitors in the device may still be charged even though the device has been disconnected from all voltage sources.

Meaning of the symbols on the device

The symbols on the device have the following meaning:





Warning of danger
(Caution, see documentation!)



Class II device

11. Declaration of conformity

CE		EG - KONFORMITÄTSERKLÄRUNG 	
		DECLARATION OF CONFORMITY	
Dokument-Nr. / Document No.:	CAM_CE-konf.DOC		
Hersteller / Manufacturer:	Camille Bauer AG Schweiz / Switzerland		
Anschrift / Address:	Aargauerstrasse 7 CH-5610 Wohlen		
Produktbezeichnung / Product name:	Universelle Messeinheit für Starkstromgrößen Universal Measuring Unit for heavy current variables		
Typ / Type:	SINEAX CAM		
Das bezeichnete Produkt stimmt mit den Vorschriften folgender Europäischer Richtlinien überein, nachgewiesen durch die Einhaltung folgender Normen:			
The above mentioned product has been manufactured according to the regulations of the following European directives proven through compliance with the following standards:			
Nr. / No.	Richtlinie / Directive		
2004/108/EG 2004/108/EC	Elektromagnetische Verträglichkeit - EMV - Richtlinie Electromagnetic compatibility -EMC directive		
EMV / EMC	Fachgrundnorm / Generic Standard	Messverfahren / Measurement methods	
Störaussendung / Emission	EN 61000-6-4 : 2007	EN 55011 : 2007+A2:2007	
Störfestigkeit / Immunity	EN 61000-6-2 : 2005	IEC 61000-4-2: 1995+A1:1998+A2:2001 IEC 61000-4-3: 2006+A1:2007 IEC 61000-4-4: 2004 IEC 61000-4-5: 2005 IEC 61000-4-6: 2008 IEC 61000-4-8: 1993+A1:2000 IEC 61000-4-11: 2004	
Nr. / No.	Richtlinie / Directive		
2006/95/EG 2006/95/EC	Elektrische Betriebsmittel zur Verwendung innerhalb bestimmter Spannungsgrenzen - Niederspannungsrichtlinie - CE-Kennzeichnung : 95 Electrical equipment for use within certain voltage limits - Low Voltage Directive - Attachment of CE mark : 95		
EN/Norm/Standard	IEC/Norm/Standard		
EN 61 010-1 : 2001	IEC 1010-1 : 2001		
Ort, Datum / Place, date:	Wohlen, 17. Februar. 2009		
Unterschrift / signature:			
M. Ulrich Leiter Technik / Head of engineering	J. Brem Qualitätsmanager / Quality manager		